



**SALINE-FILLED & SPECTRUM™ BREAST IMPLANTS**

**DIRECTIONS FOR USE**

102910-001 Rev.A Effective 13Mar09

**CAUTION: Federal (USA) law restricts this device to sale by or on the order of a physician.**

**DEVICE DESCRIPTION**

Mentor's Saline-Filled and Spectrum™ Breast Implants are constructed from room temperature vulcanized silicone elastomer, made of polydimethylsiloxane. The silicone elastomer shell is inflated to the desired size with sterile isotonic saline before implantation, as well as postimplantation for the Spectrum implants. The implants are available with Siltex® textured or smooth surface shells.

Each implant is supplied sterile with a disposable fill tube and reflux valve. The following lists the styles of Mentor saline-filled implants.

**Saline-Filled Breast Implant Family (fixed volume):**

**• Round Styles:**

- Style 1600: Smooth shell surface, anterior diaphragm valve, moderate profile
- Style 2000: Smooth shell surface, anterior diaphragm valve, moderate plus profile
- Style 2600: Siltex® textured shell surface, anterior diaphragm valve, moderate profile
- Style 3000: Smooth shell surface, anterior diaphragm valve, high profile

**• Contour Styles:**

- Style 2700: Siltex® textured shell surface, anterior diaphragm valve, high profile
- Style 2900: Siltex® textured shell surface, anterior diaphragm valve, moderate profile

**Spectrum® Breast Implant Family (post-operative adjustability):**

**• Round Styles:**

- Style 1400: Smooth shell surface, posterior kink plug valve, moderate profile
- Style 2400: Siltex® textured shell surface, posterior kink plug valve, moderate profile

**• Contour Styles:**

- Style 2500: Siltex® textured shell surface, posterior kink plug valve, high profile

The following diagrams illustrate the high and moderate contour profiles.

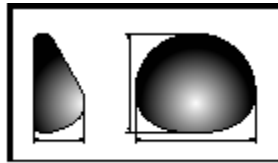

**Contour, high profile**

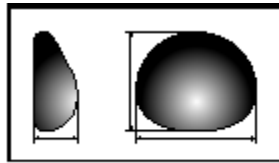

**Contour, moderate profile**

The following diagrams illustrate the moderate, moderate plus, and high profiles.

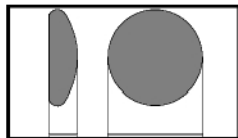

**Round, moderate profile**

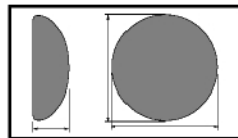

**Round, moderate plus profile**

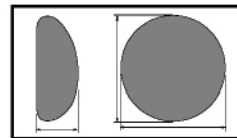

**Round, high profile**

#### INDICATIONS

*Breast implants are indicated for females for the following indications:*

- Breast Augmentation. A woman must be at least 18 years old for breast augmentation.
- Breast Reconstruction.

#### CONTRAINDICATIONS

*Patient Groups in which the product is contraindicated:*

- Active infection anywhere in the body.
- Existing malignant or pre-malignant breast cancer without adequate treatment.
- Augmentation in women who are currently pregnant or nursing.

*Surgical Practices in which product use is contraindicated due to compromise of product integrity:*

- Stacking of implants: Do not place more than one implant per breast pocket.
- Do not make injections into the implant.
- Do not alter the implant shell or valve.
- Do not place drugs or substances inside the implant other than sterile saline for injection.
- Do not allow the implant to come in contact with Betadine®.\*

#### WARNINGS

##### 1. *Closed Capsulotomy*

DO NOT treat capsular contracture by forceful external compression, which will likely result in implant damage, deflation, folds, and/or hematoma. Capsule firmness must not be treated by overexpansion of the device.

##### 2. *Reuse*

Breast implants are intended for single use only. Do not resterilize.

##### 3. *Avoiding Damage during Surgery*

- Care should be taken not to damage the prosthesis with surgical instruments.
- Do not insert or attempt to repair a damaged prosthesis.
- Use care in subsequent procedures such as open capsulotomy, breast pocket revision, hematoma/seroma aspiration, and biopsy/lumpectomy to avoid damage to the implant shell or valve.
- Do not contact the implant with disposable, capacitor-type cautery devices.

##### 4. *Proper Filling*

Follow the recommendation on the product data sheet for fill volume; do not overfill or underfill the implant.

***Underfilled prostheses may buckle, fold or wrinkle, causing crease/fold failure of the device, and subsequent deflation can occur. Additionally, inflation beyond the maximum volume can also cause crease/fold failure and deflation.***

##### 5. *Microwave Diathermy*

The use of microwave diathermy in patients with breast implants is not recommended, as it has been reported to cause tissue necrosis, skin erosion, and extrusion of the implant.

6. Do not use endoscopic placement or periumbilical approach in placement of the implant.

#### PRECAUTIONS

##### 1. *Specific Populations*

Safety & Effectiveness has not been established in patients with:

- Autoimmune diseases such as lupus and scleroderma.
- A compromised immune system (e.g., currently receiving immunosuppressive therapy).
- Patients with conditions or medications which interfere with wound healing ability (such as poorly controlled diabetes) or blood clotting (such as concurrent coumadin therapy).
- Reduced blood supply to breast tissue.

\*Betadine® is a registered trademark of the Purdue Frederic Company.

2. *Mammography*

Breast implants may complicate the interpretation of mammographic images by obscuring underlying breast tissue and/or by compressing overlying tissue. Accredited mammography centers and use of displacement techniques are needed to adequately visualize breast tissue in the implanted breast.

Presurgical mammography with a follow-up mammogram 6 months to 1 year following surgery may be performed to establish a baseline for future routine mammography.

3. *Radiation to the Breast*

Mentor has not tested the *in vivo* effects of radiation therapy in patients who have breast implants. The literature suggests that radiation therapy may increase the likelihood of capsular contracture, necrosis, and extrusion.

4. *Long-Term Effects*

Mentor has monitored the long-term risks of implant rupture, reoperation, implant removal, and capsular contracture out through 10 years.

5. *Instructions to Patients:*

- Reoperation – Patients should be advised that additional surgery to their breast and/or implant will be likely over the course of their life.
- Explantation – Patients should be advised that implants are not considered lifetime devices and they will likely undergo implant removal, with or without replacement, over the course of their life. Patients should also be advised that the changes to their breast following explantation are irreversible.
- Mammography – Patients should be instructed to inform their mammographers about the presence of their implants.
- Lactation – Patients should be advised that breast implants may interfere with the ability to successfully breast feed.
- Breast Examination Techniques - Patients should be instructed to perform breast self-examinations monthly and be shown how to distinguish the implant from their breast tissue. The patient should be instructed not to manipulate (i.e., squeeze) the valve excessively, which may cause valve leakage.

**ADVERSE EVENTS**

Mentor Corporation implants were evaluated in two prospective open label clinical studies: the Large Simple Trial (LST, which involved 2385 patients) and the Saline Prospective Study (SPS, which involved 1680 patients). The cumulative Kaplan-Meier risk of first occurrence of adverse events (and 95% confidence interval) reported in greater than 1% of patients is shown in Tables 1 and 2 on a by patient basis based on indication.

**Table 1. LST: 1-Year Cumulative First Occurrence Kaplan-Meier Adverse Event Risk Rates (95% Confidence Interval), By Patient.**

Complication	Augmentation		Reconstruction		Revision	
	Rate (%)	(95% CI)	Rate (%)	(95% CI)	Rate (%)	(95% CI)
Capsular Contracture III/IV	4.6%	(3.5, 5.7)	29.0%	(20.1, 37.8)	14.5%	(8.9, 20.1)
Implant Removal with or without Replacement	3.6%	(2.6, 4.5)	9.5%	(3.8, 15.3)	6.0%	(1.9, 10.2)
Leakage/Deflation	1.4%	(0.7, 2.0)	NA*	NA*	2.3%	(0.0, 4.8)
Infection	0.9%	(0.5, 1.4)	NA*	NA*	NA*	NA*

\*Insufficient numbers of patients to calculate a Kaplan-Meier risk rate.

**Table 2.** SPS: 3-Year Cumulative First Occurrence Kaplan-Meier Adverse Event Risk Rates (95% Confidence Interval), By Patient.

Complication	Augmentation		Reconstruction	
	By Patient N=1264		By Patient N=416	
	Rate (%)	(95% CI)	Rate (%)	(95% CI)
Wrinkling	20.8%	(18.4, 23.2)	20.0%	(15.4, 24.5)
Reoperation	13.2%	(11.2, 15.2)	40.1%	(35.0, 45.3)
Loss of Nipple Sensation	10.2%	(8.4, 12.0)	34.5 %	(29.0, 40.0)
Capsular Contracture III/IV or grade unknown	9.0%	(7.3, 10.7)	30.0%	(24.5, 34.8)
Implant Removal for Any Reason	8.1%	(6.5, 9.7)	26.8%	(22.2, 31.5)
Asymmetry	6.7%	(5.2, 8.1)	27.9%	(23.0, 32.7)
Breast Pain	5.1%	(3.8, 6.5)	17.2%	(12.5, 21.9)
Intense Nipple Sensitivity	4.8%	(3.5, 6.1)	<1%	<1%
Leakage/Deflation	3.3%	(2.2, 4.5)	9.2%	(5.7, 12.7)
Hypertrophic Scarring	2.2%	(1.3, 3.0)	4.9%	(2.6, 7.2)
Infection	1.7%	(0.97, 2.5)	9.0%	(6.0, 12.1)
Implant Palpability	1.6%	(0.88, 2.4)	<1%	<1%
Hematoma	1.5%	(0.80, 2.2)	1.3%	(0.16, 2.4)
Ptosis	1.5%	(0.80, 2.2)	<1%	<1%
Delayed Wound Healing	<1%	<1%	5.8%	(3.5, 8.1)
Implant Extrusion	<1%	<1%	2.4%	(0.72, 4.0)
Implant Malposition	<1%	<1%	1.1%	(0.02, 2.2)
Seroma	<1%	<1%	5.9%	(3.6, 8.3)
Tissue/Skin Necrosis	<1%	<1%	2.0%	(0.64, 3.4)
Irritation/Inflammation	<1%	<1%	7.6%	(4.6, 10.5)

**Table 3a.** SPS: Types of Additional Surgical Procedures through 3 Years for Augmentation

Of the 1264 augmentation patients, there were 147 (11.6%) who underwent at least one additional surgical procedure over the 3 years of follow-up in the SPS. A total of 358 additional surgical procedures were performed in augmentation patients over the 3 years of the SPS. The types of additional surgical procedures are shown below based on the number of procedures.

Types of Additional Surgical Procedures for Augmentation	N = 358 procedures	
	n	%
Implant Removal with Replacement	116	32%
Capsule Related <sup>1</sup>	77	22%
Scar or Wound Revision	67	19%
Reposition Implant	29	8%
Saline Adjustment	27	8%
Mastopexy	23	6%
Implant Removal without Replacement	9	3%
Biopsy/Cyst Removal	6	2%
Breast Reduction or Mastectomy	3	<1%
Unplanned Nipple Related Procedure	1	<1%
<b>Total</b>	<b>358</b>	<b>100%</b>

<sup>1</sup>Capsule procedures include open capsulotomy and capsulectomy.

**Table 3b.** SPS: Types of Additional Surgical Procedures through 3 Years for Reconstruction

Of the 416 reconstruction patients in the SPS, 149 (35.8%) underwent at least one additional surgical procedure over the 3 years of follow-up. A total of 353 additional surgical procedures were performed in reconstruction patients over the 3 years. The types of additional surgical procedures are shown below based on the number of procedures.

Types of Additional Surgical Procedures for Reconstruction	N = 353 procedures	
	n	%
Capsule Related <sup>1</sup>	99	28%
Implant Removal with Replacement	66	19%
Scar or Wound Revision	47	13%
Implant Removal without Replacement	40	11%
Unplanned Nipple Related Procedure	29	8%
Saline Adjustment	23	7%
Reposition Implant	20	6%
Biopsy/Cyst Removal	2	<1%
Breast Reduction or Mastectomy	2	<1%
Mastopexy	1	<1%
<b>Total</b>	<b>353</b>	<b>100%</b>

<sup>1</sup>Capsule related includes open capsulotomy and capsulectomy.

**Table 4a.** SPS: Reasons for Implant Removal through 3 Years for Augmentation

Of the 1264 augmentation patients, there were 87 patients (6.9%) who had 137 implants removed over the 3 years of follow-up in the SPS. Of the 137 augmentation implants removed, 82% were replaced. The primary reason for implant removal is shown in the table below based on the number of implants removed.

Main Reason for Implant Removal through 3 Years for Augmentation <sup>1</sup>	N = 137 implants Removed	
	n	%
Patient Request for Size/Style Change	50	37%
Leakage/Deflation	33	24%
Capsular Contracture	25	18%
Wrinkling	7	5%
Infection	7	5%
Asymmetry	5	4%
Hematoma/Seroma	3	2%
Ptosis	2	2%
Hypertrophic Scarring	2	2%
Aesthetic Revision	2	2%
Breast Cancer	1	<1%
<b>Total</b>	<b>137</b>	<b>100%</b>

<sup>1</sup> Correction to some rates reported at 3 years. Total number of implants removed increased by 1.

**Table 4b.** SPS: Reasons for Implant Removal through 3 Years for Reconstruction

Of the 416 reconstruction patients, there were 97 patients (23.3%) who had 116 implants removed over the three years of follow-up in the SPS. Of the 116 reconstruction implants removed, 60% were replaced. The primary reason for implant removal is shown in the table below based on the number of implants removed.

Main Reason for Implant Removal through 3 Years for Reconstruction <sup>1</sup>	N = 116 implants Removed	
	n	%
Capsular Contracture	35	30%
Infection	28	24%
Leakage/Deflation	26	22%
Patient Request for Size/Style Change	7	6%
Necrosis/Extrusion	6	5%
Asymmetry	5	4%
Breast Pain	4	3%
Delayed Wound Healing	2	2%
Wrinkling	1	1%
Aesthetic Revision	1	1%
Breast Cancer	1	<1%
<b>Total</b>	<b>116</b>	<b>100%</b>

<sup>1</sup> Correction to some rates reported for 3 years. Total number of implants removed did not change.

---

## POTENTIAL ADVERSE EVENTS

The following is a list of potential adverse events that may occur with breast implant surgery. Some of these adverse events have been previously reported in tables 1 and 2 above. The risks include: implant deflation/leakage, additional surgery, capsular contracture, infection, Toxic Shock Syndrome, necrosis, hematoma, seroma, extrusion, breast pain, changes in nipple sensation, changes in breast sensation, dissatisfaction with cosmetic results (wrinkling, folding, displacement, asymmetry, palpability, visibility, ptosis, sloshing), calcific deposits, irritation/inflammation, delayed wound healing, hypertrophic scarring, breast tissue atrophy/chest wall deformity, difficulty/inability in breast feeding, and inability to adequately visualize breast lesions with mammography.

In addition to these potential adverse events, there have been concerns with certain systemic diseases.

- **Connective Tissue Disease**

Concern over the association of breast implants to the development of autoimmune or connective tissue diseases, such as lupus, scleroderma, or rheumatoid arthritis, was raised because of cases reported in the literature with small numbers of women with implants. A review of several large epidemiological studies of women with and without implants indicates that these diseases are no more common in women with implants than those in women without implants.

- **Cancer**

Published studies indicate that breast cancer is no more common in women with implants than those without implants.

- **Second Generation Effects**

There have been concerns raised regarding potential damaging effects on children born of mothers with implants. A review of the published literature on this issue suggests that the information is insufficient to draw definitive conclusions.

## CLINICAL STUDIES OVERVIEW

### 1. STUDY DESIGN

The safety and effectiveness of Mentor Corporation Saline-filled implants were evaluated in 2 open label multicenter clinical studies: LST and SPS. Patients studied were those seeking breast augmentation or reconstruction. The LST was designed as a 1-year study to assess four safety outcomes for a large number of patients.

The SPS was a 3-year study to assess safety and effectiveness. Patient follow-up was yearly for 3 years. Safety endpoints consisted of complication rates. Effectiveness was assessed by patient satisfaction, breast size change, and measures of body esteem/self-esteem/body image.

**Refer to the Post-approval Study section for five-year SPS study data.**

### 2. PATIENT ACCOUNTING AND BASELINE DEMOGRAPHIC PROFILE

The LST enrolled 2066 augmentation, 104 reconstruction, and 215 revision patients, of which 47% were available for their 1-year visit. There were no deaths in the LST. The SPS consisted of 1264 eligible augmentation patients and 416 eligible reconstruction patients. Data are available for 76% of the eligible augmentation patients and 68% of the eligible reconstruction patients at 3 years post-implantation. There were 15 deaths in the SPS; none were related to the implant or the surgery.

In the SPS, the average age at surgery was 31.9 years for augmentation patients and 45.9 years for reconstruction patients.

With respect to surgical baseline factors in the SPS, for augmentation patients, the most frequently used devices were textured, the most common incision sites were periareolar and inframammary, and the most frequent site of placement was submuscular. For reconstruction patients, the most frequently used devices were Spectrum and textured, the most common incision site was the mastectomy scar, submuscular placement was the favored site, and breast reconstruction was delayed rather than immediate in the majority of patients.

### 3. SAFETY OUTCOMES

The LST safety outcomes are presented in Table 1 above.

The SPS safety outcomes for primary implantation are presented in Tables 2-4 above.

As additional safety information, Table 5 below shows the 3-year cumulative Kaplan-Meier adverse event rates of first occurrence following implant replacement (i.e., revision) on a by implant basis for complications occurring in at least 1% of patients. There were 113 augmentation patients and 70 reconstruction patients who underwent replacement of their implants. For those patients, follow-up data were available on 120 augmentation implants and 76 reconstruction implants.

**Table 5a:** SPS: 3-Year Cumulative First Occurrence Kaplan-Meier Adverse Event Risk Rates (95% Confidence Interval) Following Augmentation Implant Replacement, by Implant

Complication Following Replacement of Augmentation Implants	3-Year Risk Rate N = 120 implants	95% CI
Reoperation	15.8%	(8.9, 22.3)
Wrinkling	14.6%	(8.0, 21.2)
Implant Removal	12.1%	(5.9, 18.3)
Capsular Contracture III/IV and grade unknown	9.1%	(3.0, 15.1)
Leakage/Deflation	4.4%	(0.0, 8.8)
Asymmetry	3.8%	(0.1, 7.5)
Breast Pain	3.0%	(0.0, 5.5)
Hematoma	1.7%	(0.0, 4.1)
Hypertrophic Scarring	2.0%	(0.0, 4.8)

**Table 5b:** SPS: 3-Year Cumulative First Occurrence Kaplan-Meier Adverse Event Risk Rates (95% Confidence Interval) Following Reconstruction Implant Replacement, by Implant

Complication Following Replacement of Reconstruction Implants	3-Year Risk Rate N = 76 implants	95% CI
Reoperation	30.6%	(18.4, 43.0)
Leakage/Deflation	22.6%	(9.9, 35.3)
Implant Removal	21.1%	(10.6, 31.5)
Capsular Contracture III/IV and grade unknown	18.9%	(8.5, 29.1)
Asymmetry	17.1%	(5.8, 28.3)
Wrinkling	16.0%	(5.0, 27.0)
Breast Pain	13.1%	(2.9, 23.3)
Infection	4.7%	(0.0, 9.9)
Irritation/Inflammation	3.0%	(0.0, 7.1)
Seroma	3.0%	(0.0, 7.0)
Extrusion	1.9%	(0.0, 5.4)
Hypertrophic Scarring	1.6%	(0.0, 4.6)
Hematoma	1.5%	(0.0, 4.5)
Necrosis	1.4%	(0.0, 4.2)

**Breast Disease and Connective Tissue Disease (CTD)**

Breast disease and CTD were reported in some patients through 3 years. These data should be interpreted with the precaution in that there was no comparison group of similar women without implants. New cases of breast cancer were reported in 2 augmentation patients through 3 years. Tables 6a and 6b summarize post-implant observations from the SPS pertaining to CTD. Unconfirmed reports were based on self reports by the patients. Confirmed reports were based on a diagnosis by a physician.

**Table 6a.** SPS: Reports of CTD through 3 Years for Augmentation, By Patient.

Number of Reports of CTD in AUGMENTATION Patients in the SPS Study		
Rheumatic Disease	No. of Confirmed Reports in Patients	No. of Unconfirmed Reports in Patients
Osteoarthritis		1
Rheumatoid Arthritis	1	3
Arthritis (type unknown)		15
Lupus Erythematosus	1	
<b>Total</b>	<b>2</b>	<b>19<sub>a</sub></b>
2 aug pts had 2 unconfirmed CTDs		

**Table 6b.** SPS: Reports of CTD through 3 Years for Reconstruction, By Patient.

Number of Reports of CTD in RECONSTRUCTION Patients in the SPS Study		
Rheumatic Disease	No. of Confirmed Reports in Patients	No. of Unconfirmed Reports in Patients
Osteoarthritis	2	8
Rheumatoid Arthritis		2
Arthritis (type unknown)	1	18
Ankylosing spondylitis	1	
<b>Total</b>	<b>4</b>	<b>28</b>
7 recon pts had 2 unconfirmed CTDs		

**SUBGROUP ANALYSES**

Cox-Regression analyses were performed to identify risk factors for the complications of deflation, capsular contracture (Baker Class III or IV), infection, explantation, and reoperation. Selected significant results of these analyses are summarized below:

- Deflation was significantly higher with Betadine®\* surgical pocket irrigation than without.
- Capsular contracture (Baker Class III or IV) rate was significantly higher in older than in younger patients.
- Capsular contracture (Baker Class III or IV) rates were lower in the inframammary approach in augmentation compared to periareolar.
- There was no difference in capsular contracture (Baker Class III or IV) rate for textured versus smooth implants.
- Spectrum Breast Implants were associated with a higher implant removal and reoperation rate compared to the Saline-Filled Breast Implants.

**4. Effectiveness Outcome**

For augmentation, effectiveness outcomes included breast size change, patient satisfaction, and comfort with appearance. For reconstruction, effectiveness outcomes included breast size change, level of functional living, and depression. These outcomes were reported before implantation and at three years after surgery for those patients who still had at least one of their original implants.

For augmentation patients, 955 out of the original 1264 patients (76%) still had implants and were in the study after 3 years. Of these 955 patients, 917 (96%) experienced an increase of at least one cup size at 3 years; the average increase in chest circumference was 2.8 inches. Of the 955 patients still in the study, 860 (90%) indicated being satisfied with the general appearance of their breasts, as measured by the Breast Evaluation Questionnaire (BEQ).

Most augmentation patients who still had their original implants and were still in the study at 3 years exhibited an improvement in the two measured subscales of the Multidimensional Body-Self Relation Questionnaire (MBSRQ) (which measures comfort with your general appearance). For augmentation patients, the Tennessee Self-Concept Scale (which measures self-concept) showed a slight increase at 3 years compared to before implantation.

For reconstruction patients, 283 out of the original 416 patients (68%) still had implants and were in the study after 3 years. Of these 283 patients, the average increase in chest circumference was 1.5 inches.

**POST-APPROVAL STUDY**

After PMA approval, Mentor continued data collection in a post-approval study. The post-approval study involved the collection of some safety data from SPS patients through their 10 year post-implantation time point. The data were collected from questionnaires that were mailed out to the patients each year. The post-approval data presented includes earlier data shown in the SPS tables with new information added to it.

In terms of patient accountability, of the 1221 augmentation patients expected for follow-up at 5 years, data were collected for 5%. Of the 1191 augmentation patients expected for follow-up at 7 years, data were collected for 50%. Of the 1097 augmentation patients expected for follow-up at 10 years, data were collected for 60%. Please note that the follow-up rate at 3 years was 76% for augmentation patients, which makes the 3-year data more reliable than the 5, 7 or 10 year data. Of the 335 reconstruction patients expected for follow-up at 5 years, data were collected for 52%. Of the 309 reconstruction patients expected at 7 years, data were collected for 71%. Of the 280 reconstruction patients expected for follow-up at 10 years, data were collected for 66%. Please note that the follow-up rate at 3 years was 78% for reconstruction patients which makes the 3-year data more reliable than the 5, 7 or 10 year data.

Mentor Corporation  
P990075/S21/A03  
Saline Filled Breast Implants

There was some 5 year data reported for 54% of the augmentation patients and 73% of the reconstruction patients at some time from 3 to 10 years postoperatively. There was some 7 year data reported for 71% of the augmentation patients and 79% of the reconstruction patients at some time from 3 to 10 years postoperatively. There was some 10 year data reported for 60% of the augmentation patients and 66% of the reconstruction patients at some time from 9 to 10 years postoperatively. It is assumed that information obtained at a later time (for example, at 7 years) applies to an earlier time (for example, at 5 years), which counts on patient memory over time. This is not as reliable as information obtained at an earlier time.

The cumulative Kaplan-Meier risk of first occurrence of adverse events (and 95% C.I.) reported in greater than 1% of patients are shown in Tables 7a and 7b below.

**Table 7a:** Cumulative First Occurrence Kaplan-Meier Adverse Event Risk Rates (95% Confidence Interval) in Augmentation Patients, By Patient.

Complication	Augmentation By Patient 5 Years		Augmentation By Patient 7 Years		Augmentation By Patient 10 Years	
	N=1264		N=1158		N=1097	
Reoperation	20.2%	(17.5, 22.8)	25.3%	(22.6, 28.0)	35.9%	(32.8, 39.0)
Implant Removal	14.2%	(11.9, 16.5)	19.4%	(16.9, 21.9)	29.3%	(26.3, 32.3)
Capsular Contracture III/IV or unknown	10.1%	(8.3, 11.9)	10.7%	(8.9, 12.6)	17.5%	(14.9, 20.1)
Implant Deflation	9.7%	(7.6, 11.8)	16.5%	(14.0, 19.0)	24.7%	(21.7, 27.7)
Breast Pain	7.2%	(5.6, 8.9)	11.8%	(9.7, 13.9)	24.6%	(21.4, 27.8)

**Table 7b:** Cumulative First Occurrence Kaplan-Meier Adverse Event Risk Rates (95% Confidence Interval), in Reconstruction Patients, By Patient.

Complication	Reconstruction By Patient 5 Years		Reconstruction By Patient 7 Years		Reconstruction By Patient 10 Years	
	N=416		N = 295		N=280	
Reoperation	43%	(37.9, 48.1)	49.5%	(44.3, 54.7)	56.0%	(50.5, 61.5)
Implant Removal	30.3%	(25.5, 35.1)	39.0%	(33.9, 44.1)	45.1%	(39.6, 50.6)
Capsular Contracture III/IV or unknown	29.4%	(24.6, 34.2)	49.3%	(43.4, 55.1)	59.4%	(52.6, 66.2)
Implant Deflation	18.0%	(13.7, 22.2)	26.9%	(21.6, 32.1)	33.2%	(27.0, 39.3)
Breast Pain	16.1%	(11.8, 20.4)	28.6%	(23.3, 33.9)	37.2%	(31.0, 43.3)

The reasons for reoperation through 3, 5, 7 and 10 years are shown in Tables 8 and 9 below. The 3-year data are provided for comparative purposes because the original labeling only included 3-year types of surgical procedures. For augmentation patients, there were 255 reoperations in 146 patients at 3 years, 343 reoperations in 198 patients at 5 years, 464 reoperations in 259 patients at 7 years, and 646 reoperations in 347 patients at 10 years. For reconstruction patients, there were 209 reoperations in 149 patients at 3 years, 232 reoperations in 162 patients at 5 years, 279 reoperations in 185 patients at 7 years, and 313 reoperations in 202 patients at 10 years. Although the percentages are decreasing across the timepoints, it is because there has been an increase in the number of reoperations.

**Table 8:** Reasons for Reoperation in Augmentation Patients

Reason for Reoperation <sup>1</sup>	3 Years N = 255 Reoperations	5 Years N=343 Reoperations	7 Years N=464 Reoperations	10 Years N=646 Reoperations
Patient Request for Size/Shape Change	84 (32.9%)	98 (28.6%)	113 (24.2%)	137 (21.2%)
Capsular Contracture	49 (19.2%)	58 (16.9%)	69 (14.9%)	86 (13.3%)
Leakage/Deflation <sup>2</sup>	36 (14.1%)	66 (19.2%)	127 (27.4%)	196 (30.3%)
Wrinkling	30 (11.8%)	38 (11.1%)	45 (9.7%)	59 (9.1%)
Asymmetry	25 (9.8%)	27 (7.9%)	28 (6.0%)	37 (5.7%)
Ptosis	23 (9.0%)	32 (9.3%)	36 (7.8%)	41 (6.3%)
Hypertrophic Scarring	22 (8.6%)	22 (6.4%)	22 (4.7%)	22 (3.4%)
Hematoma/Seroma	15 (5.9%)	15 (4.4%) <sup>4</sup>	15 (3.2%)	15 (2.3%)
Infection	14 (5.5%)	15 (4.4%)	15 (3.2%)	15 (2.3%)
Aesthetic Revision	13 (5.1%)	15 (4.4%) <sup>5</sup>	16 (3.4%)	17 (2.6%)
Breast Mass/Tumor/Cyst Excision or Biopsy	7 (2.7%)	15 (4.4%)	22 (4.7%)	34 (5.3%) <sup>3</sup>
Breast Pain	3 (1.2%)	3 (0.9%)	3 (0.6%)	3 (0.5%)
Delayed Wound Healing	2 (0.8%)	2 (0.6%)	2 (0.4%)	2 (0.3%)
Irritation/Inflammation	2 (0.8%)	2 (0.6%)	2 (0.4%)	2 (0.3%)
Extrusion	2 (0.8%)	2 (0.6%)	2 (0.4%)	2 (0.3%)
Lymphadenopathy	1 (0.4%)	1 (0.3%)	1 (0.2%)	1 (0.2%)
Contralateral Replacement	0 (0.0%)	11 (3.2%)	35 (7.5%)	66 (10.2%)
Other	0 (0.0%)	0 (0.0%)	0 (0.0)	9 (1.3%) <sup>6</sup>

<sup>1</sup>If there was more than one reason reported per patient, all reasons are included in this table. <sup>2</sup>Includes 11 reoperations where deflation is assigned as worst case when the reason was not reported at 3, 5, 7 and 10 years. <sup>3</sup>Includes 24 breast mass/cancer, 4 fibroid tumors, and 5 mole/cyst removal, 1 biopsy cases. <sup>4</sup>Includes 11 hematoma and 4 seroma cases. <sup>5</sup>Includes dimpling on pectoral muscle, revise inframammary, position/shape change, and trauma. <sup>6</sup>Includes 4 prophylactic implant removal, 2 allergic reaction, 1 atypical ductal hyperplasia, 1 sclerosing adenosis, 1 prophylactic mastectomy.

**Table 9:** Reasons for Reoperation in Reconstruction Patients

Reason for Reoperation <sup>1</sup>	3 Years N = 209 Reoperations	5 Years N=232 Reoperations	7 Years N=279 Reoperations	10 Years N=313 Reoperations
Capsular Contracture	63 (30.1%)	67 (28.9%)	85 (30.5%)	90 (28.8%)
Asymmetry	45 (21.5%)	47 (20.3%)	48 (17.2%)	52 (16.6%)
Patient Request for Size/Shape Change	33 (15.8%)	37 (15.9%)	43 (15.4%)	43 (13.7%)
Staged Reconstruction	33 (15.8%)	35 (15.1%) <sup>2</sup>	33 (11.8%)	33 (10.5%)
Infection	33 (15.8%)	34 (14.7%)	34 (12.2%)	36 (11.5%)
Leakage/Deflation <sup>7</sup>	27 (12.9%)	35 (15.1%)	52 (18.6%)	59 (18.8%)
Delayed Wound Healing	18 (8.6%)	18 (7.8%)	18 (6.5%)	18 (5.6%)
Breast Pain	17 (8.1%)	17 (7.3%)	20 (7.2%)	20 (6.4%)
Hematoma/Seroma	16 (7.6%)	16 (6.9%) <sup>3</sup>	16 (5.7%)	16 (5.1%)
Hypertrophic Scarring	13 (6.2%)	13 (5.6%)	14 (5.0%)	14 (4.5%)
Wrinkling	12 (5.7%)	12 (5.2%)	13 (4.7%)	13 (4.2%)
Extrusion	9 (4.3%)	10 (4.3%)	10 (3.6%)	10 (3.2%)
Necrosis	9 (4.3%)	9 (3.9%)	9 (3.2%)	9 (2.9%)
Aesthetic Revision	9 (4.3%)	9 (3.9%) <sup>4</sup>	9 (3.2%)	10 (3.2%)
Irritation/Inflammation	8 (3.8%)	8 (3.4%)	8 (2.9%)	8 (2.6%)
Breast Mass or Cancer	4 (1.9%)	5 (2.2%)	6 (2.2%)	12 (3.8) <sup>5</sup>
Valve Malposition	1 (0.5%)	1 (0.4%)	1 (0.4%)	1 (0.3%)
Lymphadenopathy	1 (0.5%)	1 (0.4%)	1 (0.4%)	1 (0.3%)
Ptosis	0 (0.0%)	2 (0.9%)	2 (0.7%)	5 (1.6%)
Contralateral Replacement	0 (0.0%)	1 (0.4%)	4 (1.4%)	6 (1.9%)
Position Change	0 (0.0%)	0 (0.0%)	1 (0.4%)	3 (1.0%)
Other	0 (0.0%)	0 (0.0%)	0 (0.0%)	2 (0.6%) <sup>6</sup>

<sup>1</sup>If there was more than one reason reported per patient, all reasons are included in this table. This table excludes patients in which staged reconstruction was the only reason for reoperation. <sup>2</sup>These patients reported both staged reconstruction and other reason(s). See footnote 1 above. <sup>3</sup>Includes 4 hematoma and 12 seroma cases. <sup>4</sup>Includes dimpling on pectoral muscle, revise inframammary, position/shape change, and trauma. <sup>5</sup>Includes 1 removal of axillary lymph nodes. <sup>6</sup>Includes 1 prophylactic mastectomy, 1 prophylactic implant removal. <sup>7</sup>Includes 1 reoperation where deflation is assigned as worst case when the reason was not reported at 10 years.

The main reasons for implant removal through 5, 7 and 10 years are shown in Tables 10 and 11 below. At 5 years, there were 211 implants removed in 132 augmentation patients, and 135 implants removed in 112 reconstruction patients. At 7 years, there were 324 implants removed in 191 augmentation patients, and 180 implants removed in 142 reconstruction patients. At 10 years, there were 487 implants removed in 272 augmentation patients, and 206 implants removed in 158 reconstruction patients. Although the percentages are decreasing across the timepoints, it is because there has been an increase in the number of implants removed.

**Table 10: Primary Reason for Implant Removal for Augmentation Patients**

Primary Reason for Removal	5 Years N = 211 implants Removed	7 Years N= 324 Implants Removed	10 Years N= 487 Implants Removed
Patient Request for Size/Shape Change	63 (29.9%)	7 (24.1%)	102 (20.9%)
Leakage/Deflation <sup>1</sup>	63 (29.9%)	123 (38.0%)	189 (38.8%)
Capsular Contracture	31 (14.7%)	38 (11.7%)	53 (10.9%)
Wrinkling	13 (6.2%)	18 (5.6%)	27 (5.5%)
Contralateral Replacement	10 (4.7%)	32 (9.9%)	63 (12.9%)
Infection	8 (3.8%)	8 (2.5%)	8 (1.6%)
Asymmetry	7 (3.3%)	7 (2.2%)	15 (3.1%)
Breast Mass or Cancer	4 (1.9%)	5 (1.5%)	6 (1.2%)
Aesthetic Revision	4 (1.9%)	5 (1.5%)	6 (1.2%)
Ptosis	3 (1.4%)	3 (0.9%)	6 (1.2%)
Hematoma/Seroma	3 (1.4%)	3 (0.9%)	3 (0.6%)
Hypertrophic Scarring	2 (0.9%)	2 (0.6%)	2 (0.4%)
Other	0 (0.0%)	0 (0.0%)	7 (1.4%) <sup>2</sup>

<sup>1</sup>Includes 9 removals where deflation is assigned as worst case when the reason for removal was not reported at 5, 7 and 10 years. Includes one fill tube failure at 7 years. <sup>2</sup>Includes 3 prophylactic implant removal, 2 fibroid tumors, 2 allergic reaction.

**Table 11: Primary Reason for Implant Removal for Reconstruction Patients**

Primary Reason for Removal	5 Years N = 135 implants Removed	7 Years N = 180 Implants Removed	10 Years N=206 Implants Removed
Capsular Contracture	39 (28.9%)	52 (28.9%)	56 (27.2%)
Leakage/Deflation	34 (25.2%)	51 (28.3%)	57 (27.7%)
Infection	29 (21.5%)	29 (16.1%)	31 (15.0%)
Patient Request for Size/Shape Change	11 (8.1%)	17 (9.4%)	17 (8.3%)
Necrosis/Extrusion	7 (5.2%)	7 (3.9%)	7 (3.4%)
Asymmetry	5 (3.7%)	7 (3.9%)	11 (5.3%)
Breast Pain	4 (3.0%)	4 (2.2%)	4 (1.9%)
Breast Mass or Cancer	2 (1.5%)	3 (1.7%)	4 (1.9%)
Delayed Wound Healing	2 (1.5%)	2 (1.1%)	2 (1.0%)
Wrinkling	1 (0.7%)	1 (0.6%)	1 (0.5%)
Aesthetic Revision	1 (0.7%)	1 (0.6%)	2 (1.0%)
Contralateral Replacement	0 (0.0%)	3 (1.7%)	5 (2.4%)
Position Change	0 (0.0%)	1 (0.6%)	3 (1.5%)
Ptosis	0 (0.0%)	0 (0.0%)	2 (1.0%)
Hypertrophic Scarring	0 (0.0%)	1 (0.6%)	1 (0.5%)
Irritation/Inflammation	0 (0.0%)	1 (0.6%)	1 (0.5%)
Other	0 (0.0%)	0 (0.0%)	2 (1.0%) <sup>1</sup>

<sup>1</sup>Includes 1 prophylactic implant removal and 1 prophylactic mastectomy

## INSTRUCTIONS FOR USE

NOTE: It is advisable to have more than one size breast implant in the operating room at the time of surgery to allow for flexibility in determining the appropriate size implant to be used. A backup implant should also be available.

Do Not stack more than one implant per breast pocket.

### Recording Procedure

Each prosthesis is supplied with two Patient Record Labels showing the catalog number and lot number for that unit. One of these pressure sensitive labels should be attached directly to the Patient ID Card, and one to the patient's chart. The implanted position (left or right side) and the fill volume of each prosthesis should be indicated on the label.

### Sterilization

Siltex and smooth-surface saline-filled breast implants are provided sterile. They are sterilized by either gamma radiation or dry heat. The exact method can be determined by the sterilization symbol on the outer packaging. This product is for single use only. Do not resterilize.

### Implant Selection

Some of the important surgical and implant sizing variables that have been identified include the following:

- The implant should not be too small or too large in comparison to the patient's chest wall dimensions.
- Available tissue must provide adequate coverage of the implant.
- Submuscular placement of the implant may be preferable in patients with thin or poor quality tissue.
- A well-defined, dry pocket of adequate size and symmetry must be created to allow the implant to be placed flat on a smooth surface.
- Avoid too small of an incision.
- The higher profile of the Siltex shell should be considered in surgical approach.

### Testing Procedure For Saline-Filled Implants

The device should be tested for patency and shell integrity immediately prior to use. This can be accomplished by the following steps:

1. Partially inflate the prosthesis with air through the fill tube, taking care not to damage the valve (see Attaching Fill Tube instructions for the Diaphragm Valve under FILLING PROCEDURE).
2. Submerge the air-filled prosthesis in sterile, pyrogen-free testing fluid (water or saline).
3. Apply mild pressure and check for possible punctures or leaks.

### Maintaining hemostasis/Avoiding fluid accumulation

Careful hemostasis is important to prevent postoperative hematoma formation. Should excessive bleeding persist, the implantation with the device should be delayed until bleeding is controlled. Postoperative evacuation of hematoma or seroma must be conducted with care to avoid breast implant contamination, or damage from sharp instruments.

### FILLING PROCEDURE—IMPLANTS WITH DIAPHRAGM VALVES

The normal position of the diaphragm valve, which is located anteriorly, is closed. A fill tube stylet, enclosed with the product, is inserted into the implant's valve system at the time of surgery and removed intraoperatively when the desired volume is reached. Air or fluid flow into or out of the prosthesis is established by inserting the fill tube stylet, which holds the diaphragm valve open.

#### Attaching Fill Tube

1. Remove and discard the protective strip between the strap closure and valve. Push the strap closure to one side of the valve opening. To insert the fill tube into the valve opening, wet the stylet tip of the fill tube in sterile, isotonic saline, and, using the thumb and forefinger to stabilize/support the valve seat while moving the strap aside, gently push the stylet tip into the valve opening as far as the fill-tube stylet flange permits. (Figure 1a) Support of the diaphragm valve together with a gentle rotation of the fill tube during insertion facilitates ease of entry. Continue to press the stylet against the prosthesis shell until air freely escapes from the prosthesis (Figures 1b & 1c).

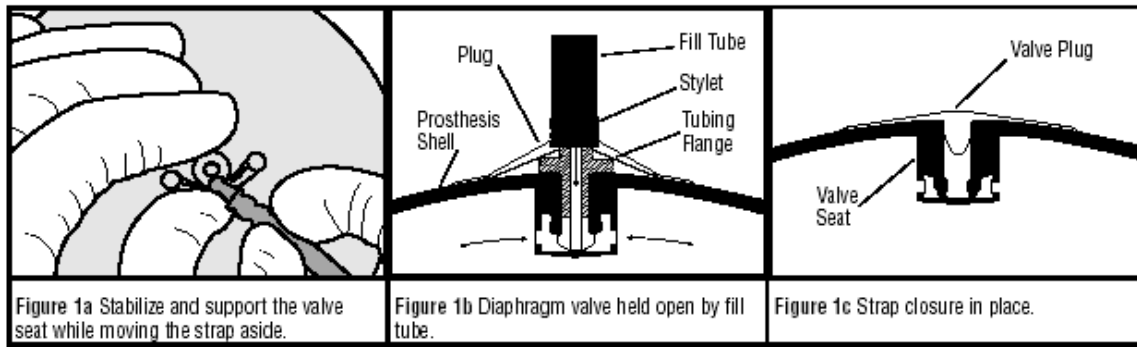

Caution: The valve system can be damaged by improper use of the fill-tube stylet. Care should be taken that the stylet enters the valve smoothly. Use the thumb and forefinger to stabilize/support the valve seat and gently push the stylet tip into the valve opening. Overstressing the valve material may result in punctures or tears and subsequent deflation may occur. Use only the fill tube stylet provided with this product. Take care not to puncture the diaphragm valve or the shell with the stylet tip. Care must also be taken when the fill tube stylet is removed to prevent damage to the valve assembly.

Deflation and Insertion of Implant

2. Prior to inserting the implant into the surgically prepared pocket, deflate the prosthesis completely. Attach an empty, sterile syringe to the luer-lock adapter of the fill tube and draw out as much air as possible. Remove the fill-tube stylet from the valve assembly. Fold the implant and insert it into the surgically prepared pocket. (Some surgeons prefer to leave the fill tube inserted in the implant, or partially fill the implant prior to placement. If the fill tube is left inserted in the implant, use of the enclosed two-way check valve on the luer lock will prevent air from re-entering the prosthesis through the fill tube after deflation.) Whatever method is used, evacuation of the air from the implant and the fill tube as indicated will minimize the air to be removed after prosthesis insertion.

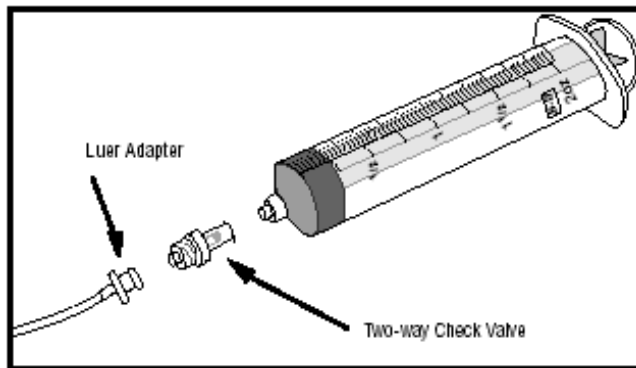

Figure 2 - Luer lock, two-way check valve and syringe assembly.

Filling the Implant

3. Prior to adding fluid to the implant, the enclosed two-way check valve should be attached to the luer adapter of the fill tube (Figure 2). The two-way check valve opens when the syringe is attached and closes when the syringe is removed. The fill tube and stylet, luer-lock adapter, and check valve are used to facilitate intraoperative filling of the prosthesis and must not be implanted.
4. Use a syringe filled with sterile, pyrogen-free Sodium Chloride U.S.P. Solution for Injection to fill the prosthesis to the recommended volume (see specifications on product labeling). Only sterile, pyrogen-free Sodium Chloride U.S.P. Solution for Injection drawn from its original container should be used. As it is known that bacterial infections may result from contaminated saline, it is recommended that a new sterile saline container be used with each surgery and implant-filling procedure.

At no time should an implant be filled with less than the minimum recommended volume or with more than the maximum recommended volume (see product labeling). The suggested optimum fill capacity is the midpoint between the minimum and maximum fill volume.

NOTE: Should adjustment of volume be necessary, reinsert the fill tube (connected to syringe) and withdraw or add fluid as needed.

5. Entrapped air may be removed by leaving the fill tube in place after filling and using the attached syringe to draw out as much air as possible. Any remaining air will eventually diffuse out and be absorbed by tissue.
6. When removing the fill-tube assembly from the valve, support area around diaphragm valve, grasp the stylet hub and avoid pulling directly on the fill tubing.
7. Entrapped fluid in the valve opening should be removed by gently manipulating the valve between the thumb and forefinger after the fill tube has been removed. To help retard tissue ingrowth or fluid accumulation in the valve opening, always engage the strap closure (see Figure 1c).
8. At the time of wound closure, extreme care should be taken not to damage the implant with surgical instruments. Preplacement of deep sutures may help to avoid inadvertent product contact with suture needles and subsequent product damage.

#### FILLING PROCEDURE – SPECTRUM IMPLANTS WITH KINK PLUG VALVES

The Spectrum volume is postoperatively adjustable. The silicone elastomer fill tube is inserted into the self-sealing valve at the time of manufacture. The prosthesis volume can be adjusted postoperatively via the fill tube and an injection dome. A connector system is used to join the preinserted fill tube to the injection dome. Two types of connector systems and two types of injection domes are provided with each product, and either may be used. Once the desired volume is achieved, the fill tube and injection dome are removed through a small incision under local anesthetic.

**Connector Systems (see the Connection Systems instructions provided in the connector and dome package):**

1. The Mentor True-Lock®\* connector does not require a suture tie.
2. The stainless steel connector does require suture material tied around tube and connector to secure the connection.

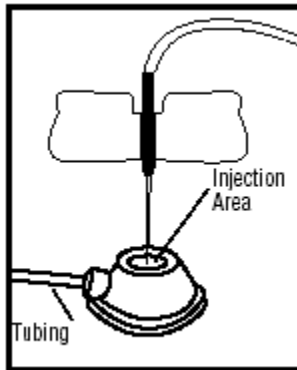

Figure 1

#### Injection Domes (used for temporary subcutaneous implantation):

1. The micro injection dome may be used when diminished palpability is desirable. This dome is designed to withstand up to 10 total injections. It is suggested that the dome be placed in a relatively superficial location to allow ease of identification and access during subsequent filling procedures. Inflation is accomplished by using pyrogen-free, sterile Sodium Chloride U.S.P. Solution for injection. Use a 21 gauge (or finer) standard or butterfly needle. Extreme care should be taken to puncture only the center of the top surface of the micro injection dome (Figure 1).
2. The standard injection dome is larger in diameter and height than the micro injection dome and can withstand up to 20 total injections.

The tube which connects the implant to the injection dome should be carefully sized to avoid kinks. Careful attachment of the fill tube to the Tru-Lock or stainless steel connector is important to prevent separation. Failure of the device to inflate may be due to kinking of the tube, leakage, separation of the components or injections which do not penetrate the injection dome.

Filling and Connection Procedure

1. Prior to inserting the prosthesis into the surgically prepared pocket, deflate the device completely.
2. Fold the prosthesis and insert it into the surgically prepared pocket. (Some surgeons prefer to partially fill the prosthesis prior to placement.) Whatever method is used, evacuation of air from the implant and the fill tube as indicated in Step 1 will minimize the air to be removed in Step 4.

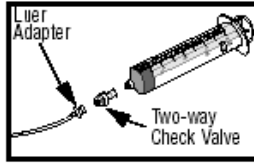

Figure 2

3. Use a syringe filled with pyrogen-free, sterile Sodium Chloride U.S.P. Solution for Injection to inflate the prosthesis to the recommended volume. A luer adapter and check valve have been included to facilitate intraoperative filling of the device, and must not be implanted (Figure 2). The enclosed two way check valve opens when a syringe is attached, and closes when the syringe is removed. Prior to adding fluid to the implant, the two-way check valve should be attached to the luer adapter of the fill tube. Only sterile, pyrogen-free, Sodium Chloride U.S.P. Solution for injection drawn from its original container should be used.

Caution: The prosthesis must not be filled to a volume less than or greater than specified (see product label and Inflation Table). The prosthesis must be filled to the "Final Range" before pulling fill tube.

4. Entrapped air may be removed by using the attached filling syringe. Any remaining air will eventually diffuse out and be absorbed by tissue.

NOTE: Should adjustment of volume be necessary during surgery, fluid may be added or removed per Steps 3 and 4.

5. If the device will not be postoperatively adjusted, the fill tube must be removed. The self-sealing valve will close to create the long-term implant.

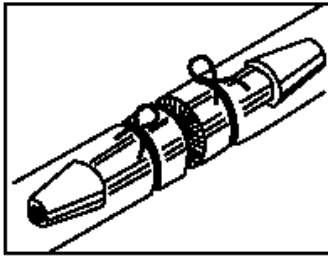

6. Should postoperative adjustability be desired, connect the fill tube to the injection dome after trimming the fill tube and discarding the luer adapter and check valve. Connect the fill tube to the desired injection dome using the connector supplied with the injection dome. Care should be taken to tailor the length of the tube so that it will not kink or shorten as the implant expands.

NOTE: If the standard or micro dome with stainless steel connector is selected, nonabsorbable suture material should be tied around the tube and connector (Figure 3) to secure the connection. It is important to securely tie the fill tube both distally and proximally to the connector so the entire fill tube assembly will be removed when the injection dome is removed from the patient. Care must be taken to secure the tube to the connector with ligatures in such a manner as to avoid cutting or occluding the tube or connector. (Further detail is provided in the Connection Systems instructions located in the connector and dome package.)

Caution: The use of forceps or hemostats to aid in the connection and suture tying process is specifically contraindicated as tube or connector damage may lead to deflation of the device.

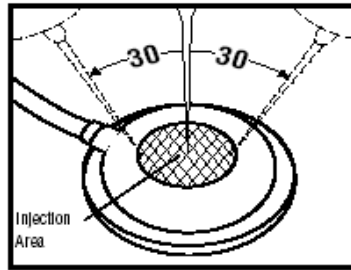

Figure 4

NOTE: If the dome pack with both domes and connector systems is selected, instructions for use for the True-Lock connector are included in the connector and dome package. Read the instructions carefully before using this connection system. It is important to securely assemble both sides of the fill tube to the connector so that the entire fill tube assembly will be removed when the injection dome is removed from the patient.

7. It is suggested that the injection dome and tube be placed high in the subcutaneous tissue adjacent to the device to allow easy identification and access during subsequent filling. The dome should be placed no less than three inches from the prosthesis to avoid damage to the device during postoperative filling. Inflation is accomplished by using sterile, pyrogen-free

Sodium Chloride U.S.P. Solution for injection. Use a 21 gauge (or finer) standard or butterfly needle. Extreme care should be taken to puncture only the center of the top surface of the injection dome at an angle perpendicular  $\pm 30^\circ$  to the top surface (Figure 4).

8. Before closing the surgical incisions, confirm that the device is patent. This can be done by inserting the 21 gauge butterfly needle, with syringe attached, into the injection dome, infusing or withdrawing fluid and observing for proper inflation/deflation of the prosthesis. Caution: At the time of wound closure, extreme care should be taken not to damage the prosthesis with surgical instruments. Preplacement of deep sutures may help to avoid inadvertent product contact with suture needles and subsequent product damage.

**Postoperative Volume Adjustment**

At no time should a prosthesis be filled with less than the Temporary Minimum Volume or with more than the Final Maximum Volume (see product label and Inflation Table). Underfilled prostheses may buckle, fold or wrinkle causing crease/fold failure of the device, and subsequent deflation can occur. Additionally, inflation beyond the Final Maximum Volume can also cause crease/fold failure and deflation. The patient must be monitored during the volume adjustment period to guard against sloughing, necrosis, wound dehiscence, etc. If at any time the overlying tissue exhibits any of these symptoms, the device should be reduced in volume (but not below the recommended Temporary Minimum Volume) by reversing the filling procedures and withdrawing fluid from the prosthesis. If signs persist, the device must be removed.

Once volume adjustments are completed, remove the injection dome and fill tube. Make a small incision at the location of the injection dome. Grasp beyond the connector and remove the tube before taking out the injection dome. This prevents the tube from dislodging and retracting back into the pocket. Do not pull on the connector while removing the tube as it may disconnect and subsequent deflation could occur. Use a slow and steady traction to remove the fill tube and thus prevent damage to the prosthesis or its self-sealing valve. Continue to pull firmly on the fill tube until the entire length of tube is withdrawn, which will be evidenced by a notch in the end of the tube.

NOTE: Mentor recommends timely volume adjustment of the device. Upon achievement of the desired volume adjustment result, the fill tube and injection dome must be removed. It is recommended that the duration of volume adjustment not exceed six months as tissue adhesions may make it more difficult to remove the fill tube and/or compromise valve integrity. Damage to the implant and/or leakage may result.

SMOOTH & SILTEX SPECTRUM® INFLATION TABLE					
Siltex Catalog Number	Smooth Catalog Number	Device Volume (cc)	Temporary* Minimum Volume (cc)	Final Minimum Volume (cc)	Final Maximum Volume (cc)
354-2410M	350-1410	125	105	125	150
354-2420M	350-1420	175	150	175	210
354-2430M	350-1430	225	190	225	270
354-2440M	350-1440	275	230	275	330
354-2450M	350-1450	325	275	325	390
354-2460M	350-1460	375	320	375	450
354-2470M	350-1470	425	360	425	510
354-2480M	350-1480	475	400	475	570
	350-1485	525	445	525	630
	350-1490	575	490	575	690

\* Temporary Minimum Volume must not exceed 90 days.

SILTEX® CONTOUR PROFILE® SPECTRUM INFLATION TABLE				
Catalog Number	Device Volume (cc)	Temporary* Minimum Volume (cc)	Final Minimum Volume (cc)	Final Maximum Volume (cc)
354-2511	275	235	275	330
354-2512	350	300	350	420
354-2513	450	380	450	540
354-2514	550	470	550	660
354-2515	650	550	650	780

\* Temporary Minimum Volume must not exceed 90 days.

#### POSTOPERATIVE CARE

Mentor recommends that the patient be wrapped superiorly with an elastic (Ace) bandage, taped laterally, and wear a surgical bra 24 hours a day to help prevent shifting of the implant.

#### DEVICE RETRIEVAL EFFORTS

Mentor requests that any explanted devices be sent to Mentor, Product Evaluation Department, 3041 Skyway Circle North, Irving, TX 75038 USA for examination and analysis.

#### PRODUCT EVALUATION

Mentor requires that any complications or explantation resulting from the use of this device be brought to the immediate attention of your local Mentor representative, who will be responsible for informing the Product Evaluation Department at Mentor, 3041 Skyway Circle North, Irving, TX 75038 USA.

#### RETURNED GOODS AUTHORIZATION

- U.S. Customers

Merchandise returned must have all manufacturer's seals intact and must be returned within 60 days from date of invoice to be eligible for credit or replacement. Please contact Mentor Customer Service Department for details. Returned products may be subject to restocking charges.

- International Customers

Authorization for return of merchandise should be obtained from your respective Mentor representative. Other conditions noted above also apply.

#### Information a Physician Should Provide to the Patient

Breast implantation is an elective procedure and the patient must be well counseled on the risk-benefit relationship. The surgeon should provide each prospective patient with the following:

- Saline-Filled Breast Implant Surgery: Making an Informed Decision.

This brochure can be used to facilitate patient education in the risks and benefits of saline-filled breast implant surgery. The patient should be advised to wait a week after reviewing and considering this information before deciding whether to have augmentation surgery.

- Patient ID Card

Enclosed with each saline-filled breast implant is a Patient ID Card. To complete the Patient ID Card, stick one Patient Record Label for each implant on the back of the Patient ID Card. Patient Record Labels are located on the internal product packaging attached to the label. If a Patient Record Label is unavailable, the lot number, catalog number and description of the device may be copied by hand from the device label. The patient should be provided with the Patient ID Card for personal reference.

#### PRODUCT ORDER INFORMATION

##### U.S. Customers















To order directly in the USA, please contact the Mentor Customer Service Department at Mentor, 201 Mentor Drive, Santa Barbara, CA 93111; Toll free telephone (800) 235-5731, FAX (805) 967-7108.

##### International Customers

For product information or to order directly, contact your local Mentor representative or the International Customer Service Department at Mentor, 201 Mentor Drive, Santa Barbara, CA 93111 USA; (805) 879-6000; FAX (805) 967-7108.

**REFERENCES**

Literature references are available upon request from:  
Mentor Marketing Services, Literature Department  
201 Mentor Drive  
Santa Barbara, CA 93111 USA

 <b>NCM. DIM.</b>	Nominal Dimensions	 Do not re-sterilize	 <b>MIN. VOL.</b>	Minimum Volume final (cc)
 <b>MIN. DIM.</b>	Minimum Dimensions	 Latex free	 <b>MAX. VOL.</b>	Maximum Volume final (cc)
 <b>QTY</b>	Quantity	 Not returnable if opened	 <b>STERILE &amp; NONPYRO</b>	The enclosed device is sterile and nonpyrogenic (unless the package has been opened or damaged).
 <b>S</b>	Style	 Fluid added	 For customer service or to return product, please call (800) 235-5731 in USA; or outside of USA, call (805) 879-6000, or contact your local representative.	
 <b>S</b>	Style: nnnn Round	 Date		
R <input type="checkbox"/> L <input type="checkbox"/>	Breast; Right (or) Left			



For customer service call (800) 235-5731 in USA; outside of USA contact your local Mentor representative.

[www.mentorcorp.com](http://www.mentorcorp.com) • [www.mentordirect.com](http://www.mentordirect.com)

<b>Manufacturer</b>	<b>European Representative</b>
MENTOR	
3041 Skyway Circle N.	Mentor Medical Systems B.V.
Irving, TX 75038-3540	
USA	Zernikedreef 2
	2333 CL, Leiden
	The Netherlands
	31- 715249600

